

FIBARO
SINGLE/DOUBLE SWITCH 2
FGS-2x3

CONTENTS

v1.2

#1: Description and features	4	#7: Associations	13
#2: Supported loads	5	#8: Z-Wave range test	14
#3: Installation	6	#9: Additional functionality	15
#4: Adding/removing the device	8	#10: Advanced parameters	16
#5: Operating the device	9	#11: Specifications	24
#6: Power and energy consumption	12	#12: Regulations	25

Important safety information



Read this manual before attempting to install the device!

Failure to observe recommendations included in this manual may be dangerous or cause a violation of the law. The manufacturer, Fibar Group S.A. will not be held responsible for any loss or damage resulting from not following the instructions of operating manual.



Danger of electrocution!

FIBARO Switch 2 is designed to operate in electrical home installation. Faulty connection or use may result in fire or electric shock.

All works on the device may be performed only by a qualified and licensed electrician. Observe national regulations.

Even when the device is turned off, voltage may be present at its terminals. Any maintenance introducing changes into the configuration of connections or the load must be always performed with disabled fuse



Required overcurrent protection

FIBARO Switch 2 must be protected with an overcurrent protection (fuse) with a value not higher than 10A.

General information about the FIBARO System

FIBARO is a wireless smart home automation system, based on the Z-Wave protocol. All of available devices can be controlled through a computer (PC or Mac), smartphone or tablet. Z-Wave devices are not only receivers, but can also repeat the signal, increasing the Z-Wave network's range. It gives advantage over traditional wireless systems that require direct link between transmitter and receiver, as a result the construction of the building could affect network's range negatively.

Every Z-Wave network has its unique identification number (home ID). Multiple independent networks can exist in the building without interfering. Transmission security of FIBARO System is comparable to wired systems.

Z-Wave technology is the leading solution in smart home automation. There is a wide range of Z-Wave devices that are mutually compatible, independently of manufacturer. It gives the system the ability to evolve and expand over time. For more information visit: www.fibaro.com.

#1: Description and features

FIBARO Switch 2 is designed to be installed in standard wall switch boxes or anywhere else where it is necessary to control electric devices. FIBARO Switch 2 allows to control connected devices either via the Z-Wave+ network or via a switch connected directly to it and is equipped with active power and energy consumption metering functionality.

i NOTE

This device may be used with all devices certified with the Z-Wave Plus certificate and should be compatible with such devices produced by other manufacturers.

i NOTE

FIBARO Switch 2 is a Security Enabled Z-Wave Plus product and a Security Enabled Z-Wave Controller must be used in order to fully utilize the product.

Main features of FIBARO Switch 2:

- Compatible with any Z-Wave or Z-Wave+ Controller,
- Supports protected mode (Z-Wave network security mode) with AES-128 encryption,
- Advanced microprocessor control,
- Active power and energy metering functionality,
- Works with various types of switches – momentary, toggle, three-way, etc,
- To be installed in wall switch boxes of dimensions allowing for installation, conforming to provisions of applicable regulations,
- FIBARO Switch 2 is an extension unit.



FIBARO Switch 2 is a fully compatible Z-Wave PLUS device.

#2: Supported loads

The Switch 2 may operate under the following loads:

- Conventional incandescent light sources,
- Halogen light sources,
- Electrical appliances which power consumption does not exceed the limit for a specified device.



Applied load and the Switch 2 itself may be damaged if the applied load is inconsistent with the technical specifications!

When connecting the Switch 2 act in accordance with the following rules:

- Do not connect loads greater than those recommended!
- Do not connect types of loads other than resistive and incandescent!

Rated load current table:

	IEC standards	UL standards
	Resistive load	
FGS-213	8A	6.5A
FGS-223	6.5A per channel 10A overall	6A per channel 9.5A overall
	Tungsten load	
FGS-213	8A	5A
FGS-223	6.5A per channel 10A overall	3A per channel

i NOTE

IEC certification applies in EU countries and most countries using 220-240V~. UL certification applies in United States and most countries using 100-120V~.

#3: Installation



Connecting the Switch 2 in a manner inconsistent with this manual may cause risk to health, life or material damage.

When connecting the Switch 2 act in accordance with the following rules:

- Connect only in accordance with one of the diagrams,
- Electrical installation must be protected by overcurrent protection (fuse) of with a value not higher than 10A,
- The Switch 2 should be installed in a wall switch box compliant with a relevant national safety standards and with depth no less than 60mm,
- Electrical switches used in installation should be compliant with the relevant safety standards,
- Length of wires used to connect the control switch should not exceed 10m.

Notes for the diagrams:

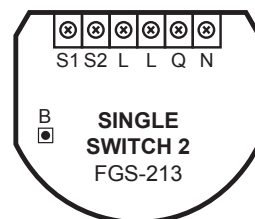

S1 - terminal for 1st switch (has the function of activating the learning mode)

S2 - terminal for 2nd switch

L - terminal for live lead

Q/Q1 - output terminal of the 1st channel

Q2 - output terminal of the 2nd channel (only Double Switch 2)

N - terminal for neutral lead

B - service button (used to add/remove the device and navigate the menu)

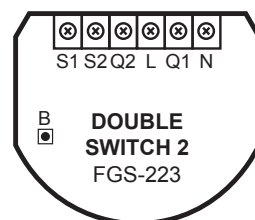

Tips for arranging the antenna:

- Locate the antenna as far from metal elements as possible (connecting wires, bracket rings, etc.) in order to prevent interferences,
- Metal surfaces in the direct vicinity of the antenna (e.g. flush mounted metal boxes, metal door frames) may impair signal reception!
- Do not cut or shorten the antenna - its length is perfectly matched to the band in which the system operates.
- Make sure no part of the antenna sticks out of the wall switch box.

Installation of the Switch 2:

1. Switch off the mains voltage (disable the fuse).
2. Open the wall switch box.
3. Connect with one of following the diagrams for appropriate device:

single wall switch:

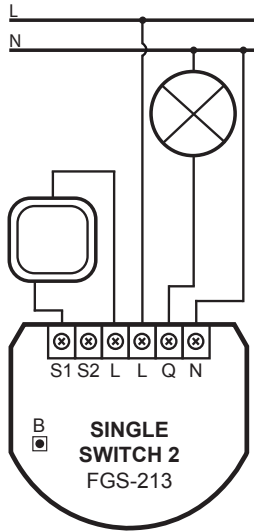

double wall switch:

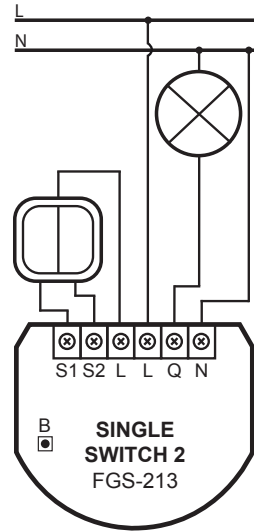

Wiring diagrams - Single Switch 2

single wall switch:

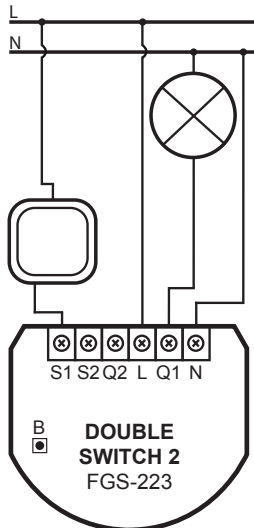

double wall switch:

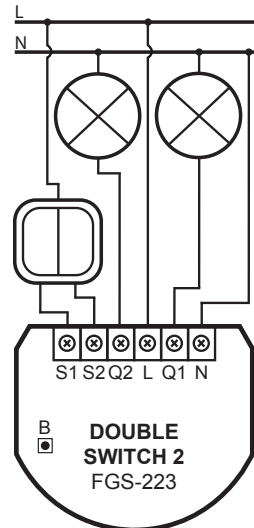

Wiring diagrams - Double Switch 2

4. After verifying correctness of the connection switch on the mains voltage.
5. Add the device to the Z-Wave network (see "Adding/removing the device" on page 8).
6. Turn off the mains voltage, then arrange the device and its antenna in a wall switch box.
7. Close the wall switch box and turn on the mains voltage.

i NOTE

Switch connected to the S1 terminal is a master switch. It activates the basic functionality of the device (turning the first load on/off) and activates the learning mode (adding/removing). The switch connected to the S2 terminal turns on/off the second load in Double Switch 2, but is optional in Single Switch 2 and pushing it will not affect the status of the device.

i NOTE

After switching on the mains voltage LED indicator will signal Z-Wave network inclusion state with a colour:

GREEN - device added
RED - device not added

#4: Adding/removing the device

NOTE

In case of problems with adding/removing using S1 switch, use B-button instead (located on the housing)

CAUTION

While adding the Switch 2 to the network with connected toggle switch, ensure that switch contact is open (off). Otherwise it will prevent adding/removing the device to/from the network.

NOTE

The device will try to add itself for 4 minutes after pressing the switch 3 times.

NOTE

Removing the Switch 2 from the Z-Wave network restores all the default parameters of the device, but does not reset power metering data.

NOTE

Adding in security mode must be performed up to 2 meters from the controller.

Adding (Inclusion) - Z-Wave device learning mode, allowing to add the device to existing Z-Wave network.

To add the device to the Z-Wave network:

1. Place the Switch 2 within the direct range of your Z-Wave controller.
2. Identify the S1 switch.
3. Set the main controller in (security/non-security) add mode (see the controller's manual).
4. Quickly, three times press the S1 switch.
5. Wait for the adding process to end.
6. Successful adding will be confirmed by the Z-Wave controller's message.

Removing (Exclusion) - Z-Wave device learning mode, allowing to remove the device from existing Z-Wave network.

To remove the device from the Z-Wave network:

1. Place the Switch 2 within the direct range of your Z-Wave controller.
2. Identify the S1 switch.
3. Set the main controller in remove mode (see the controller's manual).
4. Quickly, three times press the S1 switch.
5. Wait for the removing process to end.
6. Successful removing will be confirmed by the Z-Wave controller's message.

#5: Operating the device

Controlling the Switch 2 using a momentary switch and parameter 20 set to 0:

1x click:

- Change the state of the connected load to the opposite one (S1 switches 1st channel, S2 switches 2nd channel),
- Change the state of 2nd, 3rd (S1 switch), 4th and 5th (S2 switch) association group to the opposite one.

2x click:

- Set maximum level of devices associated in 2nd, 3rd (S1 switch), 4th and 5th (S2 switch) group.

Hold:

- Start smooth control of devices associated in 3rd (S1 switch) and 5th (S2 switch) group.

Release:

- Stop smooth control of devices associated in 3rd (S1 switch) and 5th (S2 switch) group.

Controlling the Switch 2 using a toggle switch and parameter 20 set to 1:

Close switch contact:

- Turn ON the connected load (S1 switches 1st channel, S2 switches 2nd channel),
- Turn ON devices associated in 2nd, 3rd (S1 switch), 4th and 5th (S2 switch) group.

Open switch contact:

- Turn OFF the connected load (S1 switches 1st channel, S2 switches 2nd channel).
- Turn OFF devices associated in 2nd, 3rd (S1 switch), 4th and 5th (S2 switch) group.

Controlling the Switch 2 using a toggle switch and parameter 20 set to 2:

Change switch position once:

- Change the state of the connected load to the opposite one (S1 switches 1st channel, S2 switches 2nd channel),
- Change the state of 2nd, 3rd (S1 switch), 4th and 5th (S2 switch) association group to the opposite one.

Change switch position twice:

- Set maximum level of devices associated in 2nd, 3rd (S1 switch), 4th and 5th (S2 switch) group.

NOTE

Momentary switch

After releasing the switch a spring automatically pushes back and disconnects the switch)

Toggle switch

Operates as a two-position switch, it has no spring that would set one position of the switch.

NOTE

Toggle switch and parameter 20 set to 1:

State of the device is synchronized with state of the external toggle switches.

Toggle switch and parameter 20 set to 2:

State of the device is reversed with every change in state of the external toggle switch.

Controlling the Switch 2 using the B-button:

The Switch 2 is equipped with a B-button, which allows to use the menu and perform the following actions:

1x click:

- Cancel alarm mode (flashing alarm).
- Select desired menu position (if menu is active).
- Exit range test.
- Turn 1st channel ON/OFF.

3x click:

- Send the Node Info Z-Wave command frame (adding/removing).

Hold:

- Enter the menu (confirmed by the LED indicator).

Menu allows to perform Z-Wave network actions. In order to use the menu:

1. Switch off the mains voltage (disable the fuse).
2. Remove the Switch 2 from the wall switch box.
3. Switch on the mains voltage.
4. Press and hold the B-button to enter the menu.
5. Wait for the LED to indicate the desired menu position with colour:
 - **GREEN** - reset energy consumption memory
 - **VIOLET** - start range test
 - **YELLOW** - reset the device
6. Quickly release and click the B-button again.

i NOTE

Resetting the device is not the recommended way of removing the device from the Z-Wave network. Use reset procedure only if the primary controller is missing or inoperable. Certain device removal can be achieved by the procedure of removing described in "Adding/removing the device" on page 8.

Resetting the Switch 2:

1. Switch off the mains voltage (disable the fuse).
2. Remove the Switch 2 from the wall switch box.
3. Switch on the mains voltage.
4. Press and hold the B-button to enter the menu.
5. Wait for the visual LED indicator to glow yellow.
6. Quickly release and click the B-button again.
7. After few seconds the device will be restarted, which is signalled with the red LED indicator colour.

Controlling the Switch 2 using FIBARO Home Center controller:

After adding the Switch 2 to the network, it will be represented in the Home Center interface by two similar icons, one for each channel. Icon for second channel is hidden for Single Switch 2:



Turning the device ON/OFF – ON and OFF icons are used for operating the load.

#6: Power and energy consumption

CAUTION

The Switch 2 require the power consumption of connected load equal to 5W or greater to correctly measure the power and energy.

NOTE

Power measurement can contain mains voltage fluctuations within +/- 10%.

CAUTION

The Switch 2 stores periodically (every hour) the consumption data in the device memory. Disconnecting the module from the power supply will not erase stored energy consumption data.

The Switch 2 allows for the active power and energy consumption monitoring. Data is sent to the main Z-Wave controller, e.g. Home Center.

Measuring is carried out by the most advanced micro-controller technology, assuring maximum accuracy and precision (+/- 1% for loads greater than 5W).

Electric active power - power that energy receiver is changing into a work or a heat. The unit of active power is Watt [W].

Electric energy - energy consumed by a device through a time period. Consumers of electricity in households are billed by suppliers on the basis of active power used in given unit of time. Most commonly measured in kilowatt-hour [kWh]. One kilowatt-hour is equal to one kilowatt of power consumed over period of one hour, 1kWh = 1000Wh.

Resetting consumption memory:

The Switch 2 allows to erase stored consumption data in three ways:

- a) Using functionality of a Z-Wave controller (see the controller's manual).
- b) Manually clearing the data using the following procedure:
 1. Switch off the mains voltage (disable the fuse).
 2. Remove the Switch 2 from the wall switch box.
 3. Switch on the mains voltage.
 4. Press and hold the B-button to enter the menu.
 5. Wait for the visual LED indicator to glow green.
 6. Quickly release and click the B-button again.
 7. Energy consumption memory will be erased.
- c) By resetting the device (see "Operating the device" on page 9).

#7: Associations

Association (linking devices) - direct control of other devices within the Z-Wave system network e.g. Dimmer, Relay Switch, Roller Shutter or scene (may be controlled only through a Z-Wave controller).

The Switch 2 provides the association of five groups:

1st association group – “Lifeline” reports the device status and allows for assigning single device only (main controller by default).

2nd association group – “On/Off (S1)” is assigned to switch connected to the S1 terminal (uses Basic command class).

3rd association group – “Dimmer (S1)” is assigned to switch connected to the S1 terminal (uses Switch Multilevel command class).

4th association group – “On/Off (S2)” is assigned to switch connected to the S2 terminal (uses Basic command class).

5th association group – “Dimmer (S2)” is assigned to switch connected to the S2 terminal (uses Switch Multilevel command class).

The Switch 2 in 2nd to 5th group allows to control 5 regular or multichannel devices per an association group, with the exception of “LifeLine” that is reserved solely for the controller and hence only 1 node can be assigned.

It is not recommended to associate more than 10 devices in general, as the response time to control commands depends on the number of associated devices. In extreme cases, system response may be delayed.

To add an association (using the Home Center controller):

1. Go to the device options by clicking the icon: 
2. Select the „Advanced” tab.
3. Click the “Setting Association” button.
4. Specify to which group and what devices are to be associated.
5. Save the changes.
6. Wait for the configuration process to end.

NOTE

Association ensures direct transfer of control commands between devices, is performed without participation of the main controller and requires associated device to be in the direct range.

NOTE

The Switch 2 supports the operation of multichannel devices. Multichannel devices are devices that include two or more circuits inside one physical unit.

#8: Z-Wave range test

CAUTION

To make Z-Wave range test possible, the device must be added to the Z-Wave controller. Testing may stress the network, so it is recommended to perform the test only in special cases.

NOTE

Communication mode of the Switch 2 may switch between direct and one using routing, especially if the device is on the limit of the direct range.

The Switch 2 has a built in Z-Wave network main controller's **range tester**.

Follow the below instructions to test the main controller's range:

1. Switch off the mains voltage (disable the fuse).
2. Remove the Switch 2 from the wall switch box.
3. Switch on the mains voltage.
4. Press and hold the B-button to enter the menu.
5. Wait for the visual LED indicator to glow violet.
6. Quickly release and click the B-button again.
7. Visual indicator will indicate the Z-Wave network's range (range signalling modes described below).
8. To exit Z-Wave range test, click the B-button.

Z-Wave range tester signalling modes:

Visual indicator pulsing green - the Switch 2 attempts to establish a direct communication with the main controller. If a direct communication attempt fails, the device will try to establish a routed communication, through other modules, which will be signalled by visual indicator pulsing yellow.

Visual indicator glowing green - the Switch 2 communicates with the main controller directly.

Visual indicator pulsing yellow - the Switch 2 tries to establish a routed communication with the main controller through other modules (repeaters).

Visual indicator glowing yellow - the Switch 2 communicates with the main controller through the other modules. After 2 seconds the device will retry to establish a direct communication with the main controller, which will be signalled with visual indicator pulsing green.

Visual indicator pulsing violet - the Switch 2 does communicate at the maximum distance of the Z-Wave network. If connection proves successful it will be confirmed with a yellow glow. It's not recommended to use the device at the range limit.

Visual indicator glowing red - the Switch 2 is not able to connect to the main controller directly or through another Z-Wave network device (repeater).

#9: Additional functionality

Overheat and overcurrent protection:

The Switch 2 after detecting overheat or overcurrent will:

- switch off its relay/relays,
- send information about switching off the relay/relays to the controller,
- send Notification Report to the controller (Heat Alarm for overheat, Power Management for overcurrent).

Activating scenes:

The Switch 2 can activate scenes in the Z-Wave controller by sending scene ID and attribute of a specific action using Central Scene Command Class.

By default scenes are not activated, set parameters 28 and 29 to enable scene activation for selected actions.

Switch	Action	Scene ID	Attribute
Switch connected to S1 terminal	Switch clicked once	1	Key Pressed 1 time
	Switch clicked twice	1	Key Pressed 2 times
	Switch clicked thrice	1	Key Pressed 3 times
	Switch held	1	Key Held Down
	Switch released	1	Key Released
Switch connected to S2 terminal	Switch clicked once	2	Key Pressed 1 time
	Switch clicked twice	2	Key Pressed 2 times
	Switch clicked thrice	2	Key Pressed 3 times
	Switch held	2	Key Held Down
	Switch released	2	Key Released

#10: Advanced parameters

The Switch 2 allows to customize its operation to user's needs. The settings are available in the FIBARO interface as simple options that may be chosen by selecting the appropriate box.

In order to configure the Switch 2 (using the Home Center controller):

1. Go to the device options by clicking the icon: 
2. Select the „Advanced” tab.

9. Restore state after power failure

This parameter determines if the device will return to state prior to the power failure after power is restored.

Available settings:	0 - the device does not save the state prior to the power failure and returns to „off” position 1 - the device restores its state prior to the power failure		
Default setting:	1	Parameter size:	1 [byte]

10. First channel - operating mode

This parameter allows to choose operating for the 1st channel controlled by the S1 switch.

Available settings:	0 - standard operation 1 - delay ON 2 - delay OFF 3 - auto ON 4 - auto OFF 5 - flashing mode		
Default setting:	0	Parameter size:	1 [byte]

11. First channel - reaction to switch for delay/auto ON/OFF modes

This parameter determines how the device in timed mode reacts to pushing the switch connected to the S1 terminal.

Available settings:	0 - cancel mode and set target state 1 - no reaction to switch - mode runs until it ends 2 - reset timer - start counting from the beginning		
Default setting:	0	Parameter size:	1 [byte]

12. First channel - time parameter for delay/auto ON/OFF modes

This parameter allows to set time parameter used in timed modes.

Available settings:	0 (0.1s), 1-32000 (1-32000s, 1s step) - time parameter		
Default setting:	50 (50s)	Parameter size:	2 [bytes]

13. First channel - pulse time for flashing mode

This parameter allows to set time of switching to opposite state in flashing mode.

Available settings:	1-32000 (0.1-3200.0s, 0.1s step) - time parameter		
Default setting:	5 (0.5s)	Parameter size:	2 [bytes]

15. Second channel - operating mode (FGS-223 only)

This parameter allows to choose operating for the 1st channel controlled by the S2 switch.

Available settings:	0 - standard operation 1 - delay ON 2 - delay OFF 3 - auto ON 4 - auto OFF 5 - flashing mode		
Default setting:	0	Parameter size:	1 [byte]

16. Second channel - reaction to switch for delay/auto ON/OFF modes (FGS-223 only)

This parameter determines how the device in timed mode reacts to pushing the switch connected to the S2 terminal.

Available settings:	0 - cancel mode and set target state 1 - no reaction to switch - mode runs until it ends 2 - reset timer - start counting from the beginning		
Default setting:	0	Parameter size:	1 [byte]

17. Second channel - time parameter for delay/auto ON/OFF modes (FGS-223 only)

This parameter allows to set time parameter used in timed modes.

Available settings:	0 (0.1s), 1-32000 (1-32000s, 1s step) - time parameter		
Default setting:	50 (50s)	Parameter size:	2 [bytes]

18. Second channel - pulse time for flashing mode (only FGS-223)

This parameter allows to set time of switching to opposite state in flashing mode.

Available settings:	1-32000 (0.1-3200.0s, 0.1s step) - time parameter		
Default setting:	5 (0.5s)	Parameter size:	2 [bytes]

20. Switch type

This parameter defines as what type the device should treat the switch connected to the S1 and S2 terminals.

Available settings:	0 - momentary switch 1 - toggle switch (contact closed - ON, contact opened - OFF) 2 - toggle switch (device changes status when switch changes status)		
Default setting:	2	Parameter size:	1 [byte]

21. Flashing mode - reports

This parameter allows to define if the device sends reports during the flashing mode.

Available settings:	0 - the device does not send reports 1 - the device sends reports		
Default setting:	0	Parameter size:	1 [byte]

i NOTE

Parameter 27 values may be combined, e.g. 1+2=3 means that 2nd & 3rd groups are sent as secure.

27. Associations in Z-Wave network security mode

This parameter defines how commands are sent in specified association groups: as secure or non-secure. Parameter is active only in Z-Wave network security mode. This parameter does not apply to 1st „Lifeline“ group.

Available settings:	1 - 2nd group sent as secure 2 - 3rd group sent as secure 4 - 4th group sent as secure 8 - 5th group sent as secure		
Default setting:	15 (all)	Parameter size:	1 [byte]

i NOTE

Parameter 28 values may be combined, e.g. 1+2=3 means that scenes for single and double click are sent.

28. S1 switch - scenes sent

This parameter determines which actions result in sending scene IDs assigned to them.

Available settings:	1 - Key pressed 1 time 2 - Key pressed 2 times 4 - Key pressed 3 times 8 - Key Hold Down and Key Released		
Default setting:	0	Parameter size:	1 [byte]

29. S2 switch - scenes sent

This parameter determines which actions result in sending scene IDs assigned to them.

Available settings:	1 - Key pressed 1 time 2 - Key pressed 2 times 4 - Key pressed 3 times 8 - Key Hold Down and Key Released		
Default setting:	0	Parameter size:	1 [byte]

30. S1 switch - associations sent to 2nd and 3rd association groups

This parameter determines which actions are ignored when sending commands to devices associated in 2nd and 3rd association group. All actions are active by default.

Available settings:	1 - ignore turning ON with 1 click of the switch 2 - ignore turning OFF with 1 click of the switch 4 - ignore holding and releasing the switch* 8 - ignore double click of the switch**		
Default setting:	0	Parameter size:	1 [byte]

31. S1 switch - Switch ON value sent to 2nd and 3rd association groups

This parameter defines value sent with Switch ON command to devices associated in 2nd and 3rd association group.

Available settings:	0-255 - sent value		
Default setting:	255	Parameter size:	2 [bytes]

32. S1 switch - Switch OFF value sent to 2nd and 3rd association groups

This parameter defines value sent with Switch OFF command to devices associated in 2nd and 3rd association group.

Available settings:	0-255 - sent value		
Default setting:	0	Parameter size:	2 [bytes]

33. S1 switch - Double Click value sent to 2nd and 3rd association groups

This parameter defines value sent with Double Click command to devices associated in 2nd and 3rd association group.

Available settings:	0-255 - sent value		
Default setting:	99	Parameter size:	2 [bytes]

i NOTE

Parameter 29 values may be combined, e.g. 1+2=3 means that scenes for single and double click are sent.

i NOTE

Parameter 30 values may be combined, e.g. 1+2=3 means that associations for turning ON and OFF are not sent.

i NOTE

*Hold and release is inactive when parameter 20 is set to 1 or 2.

**Double click is inactive when parameter 20 is set to 1.

i NOTE

Setting parameters 31-33, 36-38 to appropriate value should result in:

0 - turning off associated devices

1-99 - forcing level of associated devices

255 - setting associated devices to the last remembered state or turning them on

i NOTE

Parameter 35 values may be combined, e.g. 1+2=3 means that associations for turning ON and OFF are not sent.

i NOTE

*Hold and release is inactive when parameter 20 is set to 1 or 2.

**Double click is inactive when parameter 20 is set to 1.

35. S2 switch - associations sent to 4th and 5th association groups

This parameter determines which actions result in sending commands to devices associated in 4th and 5th association group. All actions are active by default.

Available settings:	1 - ignore turning on with 1 click of the switch 2 - ignore turning off with 1 click of the switch 4 - ignore holding and releasing the switch* 8 - ignore double click of the switch**		
Default setting:	0	Parameter size:	1 [byte]

36. S2 switch - Switch ON value sent to 4th and 5th association groups

This parameter defines value sent with Switch ON command to devices associated in 4th and 5th association group.

Available settings:	0-255 - sent value		
Default setting:	255	Parameter size:	2 [bytes]

37. S2 switch - Switch OFF value sent to 4th and 5th association groups

This parameter defines value sent with Switch OFF command to devices associated in 4th and 5th association group.

Available settings:	0-255 - sent value		
Default setting:	0	Parameter size:	2 [bytes]

38. S2 switch - Double Click value sent to 4th and 5th association groups

This parameter defines value sent with Double Click command to devices associated in 4th and 5th association group.

Available settings:	0-255 - sent value		
Default setting:	99	Parameter size:	2 [bytes]

40. Reaction to General Alarm

This parameter determines how the device will react to General Alarm frame.

Available settings:	0 - alarm frame is ignored 1 - turn ON after receiving the alarm frame 2 - turn OFF after receiving the alarm frame 3 - flash after receiving the alarm frame		
Default setting:	3	Parameter size:	1 [byte]

41. Reaction to Flood Alarm

This parameter determines how the device will react to Flood Alarm frame.

Available settings:	0 - alarm frame is ignored 1 - turn ON after receiving the alarm frame 2 - turn OFF after receiving the alarm frame 3 - flash after receiving the alarm frame		
Default setting:	2	Parameter size:	1 [byte]

42. Reaction to CO/CO2/Smoke Alarm

This parameter determines how the device will react to CO, CO2 or Smoke frame.

Available settings:	0 - alarm frame is ignored 1 - turn ON after receiving the alarm frame 2 - turn OFF after receiving the alarm frame 3 - flash after receiving the alarm frame		
Default setting:	3	Parameter size:	1 [byte]

43. Reaction to Heat Alarm

This parameter determines how the device will react to Heat Alarm frame.

Available settings:	0 - alarm frame is ignored 1 - turn ON after receiving the alarm frame 2 - turn OFF after receiving the alarm frame 3 - flash after receiving the alarm frame		
Default setting:	1	Parameter size:	1 [byte]

44. Flashing alarm duration

This parameter allows to set duration of flashing alarm mode.

Available settings:	1-32000 (1-32000s, 1s step) - duration		
Default setting:	600 (10min)	Parameter size:	2 [bytes]

50. First channel - power reports

This parameter determines the minimum change in consumed power that will result in sending new power report to the main controller.

Available settings:	0 - reports are disabled 1-100 (1-100%) - change in power		
Default setting:	20 (20%)	Parameter size:	1 [byte]

51. First channel - minimal time between power reports

This parameter determines minimum time that has to elapse before sending new power report to the main controller.

Available settings:	0 - reports are disabled 1-120 (1-120s) - report interval		
Default setting:	10 (10s)	Parameter size:	1 [byte]

53. First channel - energy reports

This parameter determines the minimum change in consumed energy that will result in sending new energy report to the main controller.

Available settings:	0 - reports are disabled 1-32000 (0.01 - 320 kWh) - change in energy		
Default setting:	100 (1 kWh)	Parameter size:	2 [bytes]

54. Second channel - power reports (FGS-223 only)

This parameter determines the minimum change in consumed power that will result in sending new power report to the main controller.

Available settings:	0 - reports are disabled 1-100 (1-100%) - change in power		
Default setting:	20 (20%)	Parameter size:	1 [byte]

55. Second channel - minimal time between power reports (FGS-223 only)

This parameter determines minimum time that has to elapse before sending new power report to the main controller.

Available settings:	0 - periodic reports are disabled 1-120 (1-120s) - report interval		
Default setting:	10 (10s)	Parameter size:	1 [byte]

57. Second channel - energy reports (FGS-223 only)

This parameter determines the minimum change in consumed energy that will result in sending new energy report to the main controller.

Available settings:	0 - reports are disabled 1-32000 (0.01 - 320 kWh) - change in energy		
Default setting:	100 (1 kWh)	Parameter size:	2 [bytes]

58. Periodic power reports

This parameter determines in what time interval the periodic power reports are sent to the main controller.

Available settings:	0 - periodic reports are disabled 1-32000 (1-32000s) - report interval		
Default setting:	3600 (1h)	Parameter size:	2 [bytes]

59. Periodic energy reports

This parameter determines in what time interval the periodic energy reports are sent to the main controller.

Available settings:	0 - periodic reports are disabled 1-32000 (1-32000s) - report interval		
Default setting:	3600 (1h)	Parameter size:	2 [bytes]

60. Measuring energy consumed by the device itself

This parameter determines whether energy metering should include the amount of energy consumed by the device itself. Results are being added to energy reports for first endpoint.

Available settings:	0 - function inactive 1 - function active		
Default setting:	0	Parameter size:	1 [byte]

#11: Specifications

i NOTE

IEC certification applies in EU countries and most countries using 220-240V~. UL certification applies in United States and most countries using 100-120V~.

i NOTE

Radio frequency of individual device must be same as your Z-Wave controller. Check information on the box or consult your dealer if you are not sure.

UL requirements:

- Purpose of Control: Operating Control
- Construction of Control: Independently Mounted Control
- Control Pollution Degree: 2
- Rated Impulse Voltage: 2500V
- Type 1 Action: Type 1 action according to UL 60730-1

Power supply:	100-240V~ 50/60 Hz
Rated load current:	Single Switch 2 (FGS-213): IEC standards: 8A UL standards: 6.5A - resistive loads 5A - tungsten loads
	Double Switch 2 (FGS-223): IEC standards: 6.5A per channel 10A overall
	UL standards: 6A per channel - resistive loads 3A per channel - tungsten loads 9.5A overall - resistive loads
Operating temperature:	0-35°C
For installation in boxes:	Ø ≥ 50mm, depth ≥ 60mm
Overcurrent protection:	required external 10A circuit breaker
Radio protocol:	Z-Wave (500 series chip)
Radio signal power:	up to 5dBm
Radio frequency:	868.4 or 869.8 MHz EU; 908.4, 908.42 or 916.0 MHz US; 921.4 or 919.8 MHz ANZ; 869.0 MHz RU;
Range:	up to 50m outdoors up to 40m indoors (depending on terrain and building structure)
Comply with EU directives:	RoHS 2011/65/EU RED 2014/53/EU
Dimensions (L x W x H):	42.5 x 38.25 x 20.3 mm

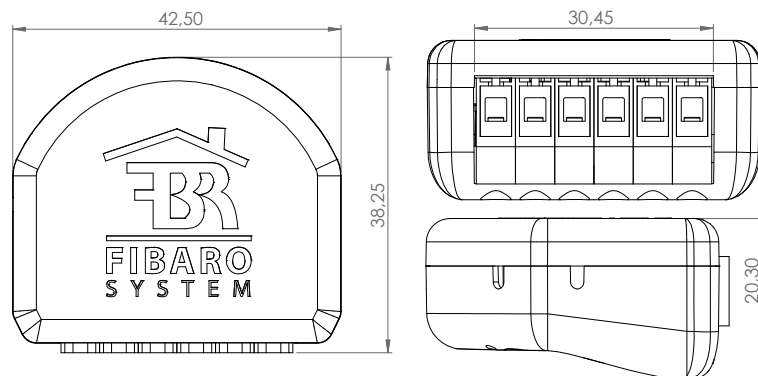

#12: Regulations

This device complies with Part 15 of the FCC Rules

Operation is subject to the following two conditions:

1. This device may not cause harmful interference
2. This device must accept any interference received, including interference that may cause undesired operation. This equipment has been tested and found to comply with the limits for a Class B digital device, pursuant to part 15 of the FCC Rules. These limits are designed to provide reasonable protection against harmful interference in a residential installation. This equipment generates, uses and can radiate radio frequency energy and, if not installed and used in accordance with the instructions, may cause harmful interference to radio communications. However, there is no guarantee that interference will not occur in a particular installation. If this equipment does cause harmful interference to radio or television reception, which can be determined by turning the equipment off and on, the user is encouraged to try to correct the interference by one or more of the following measures:

- Reorient or relocate the receiving antenna.
- Increase the separation between the equipment and receiver.
- Connect the equipment into an outlet on a circuit different from that to which the receiver is connected.
- Consult the dealer or an experienced radio/TV technician for help.

Changes and modifications not expressly approved by the manufacturer or registrant of this equipment can void your authority to operate this equipment under Federal Communications Commission's rules.

Industry Canada (IC) Compliance Notice

This device complies with Industry Canada license-exempt RSSs. Operation is subject to the following two conditions: (1) this device may not cause interference, and (2) this device must accept any interference, including interference that may cause undesired operation of the device.

Cet appareil est conforme aux normes d'exemption de licence RSS d'Industry Canada. Son fonctionnement est soumis aux deux conditions suivantes : (1) cet appareil ne doit pas causer d'interférence et (2) cet appareil doit accepter toute interférence, notamment les interférences qui peuvent affecter son fonctionnement.

Legal Notices

All information, including, but not limited to, information regarding the features, functionality, and/or other product specification are subject to change without notice. Fibaro reserves all rights to revise or update its products, software, or documentation without any obligation to notify any individual or entity.

FIBARO and Fibar Group logo are trademarks of Fibar Group S.A. All other brands and product names referred to herein are trademarks of their respective holders.

DGT Warning Statement

Article 12

Without permission, any company, firm or user shall not alter the frequency, increase the power, or change the characteristics and functions of the original design of the certified lower power frequency electric machinery.

Article 14

The application of low power frequency electric machineries shall not affect the navigation safety nor interfere a legal communication, if an interference is found, the service will be suspended until improvement is made and the interference no longer exists.

第十二條

經型式認證合格之低功率射頻電機，非經許可，公司、商號或使用者均不得擅自變更頻率、加大功率或變更原設計之特性及功能。

第十四條

低功率射頻電機之使用不得影響飛航安全及干擾合法通信；經發現有干擾現象時，應立即停用，並改善至無干擾時方得繼續使用。

前項合法通信，指依電信法規定作業之無線電通信。

低功率射頻電機須忍受合法通信或工業、科學及醫療用電波輻射性電機設備之干擾。

Declaration of conformity

 Hereby, Fibar Group S.A. declares that the device is in compliance with the essential requirements and other relevant provisions of Directive 2014/53/EU. The full text of the EU declaration of conformity is available at the following internet address: www.manuals.fibaro.com

WEEE Directive Compliance



Device labelled with this symbol should not be disposed with other household wastes. It shall be handed over to the applicable collection point for the recycling of waste electrical and electronic equipment.

